

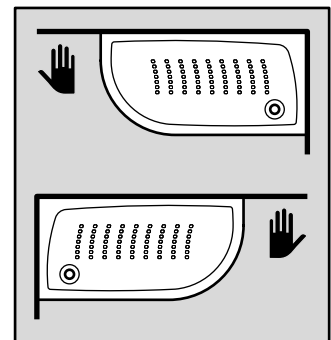

DAIQUIRI

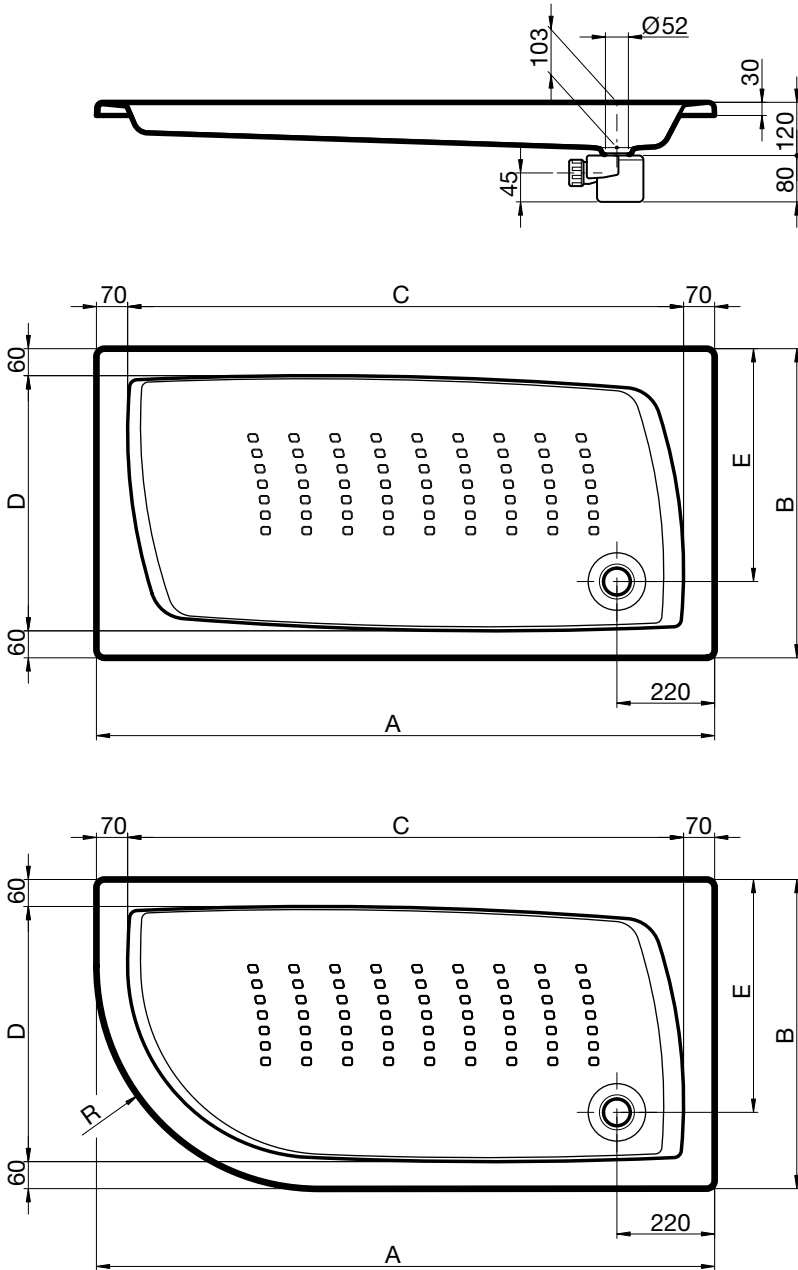

	1700x750	1600x750	1700x700	1600x700	1400x750 Dr/lz	1400x700	1200x800	1200x750	1200x700	1000x800	1000x750 Dr/lz	1000x700	900x750	900x700
A	1700	1600	1700	1600	1400	1400	1200	1200	1200	1000	1000	1000	900	900
B	750	750	700	700	750	700	800	750	700	800	750	700	750	700
C	1560	1460	1560	1460	1260	1260	1060	1060	1060	860	860	860	760	760
D	630	630	580	580	630	580	680	630	580	680	630	580	630	580
E	575	575	525	525	575	525	625	575	525	625	575	525	575	525
R	-	-	-	-	504	-	-	-	-	-	504	-	-	-



1

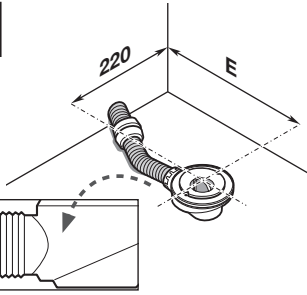

2

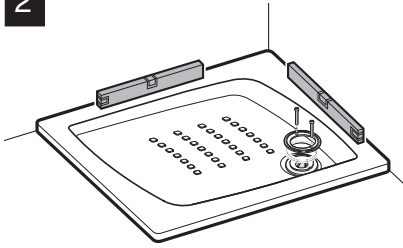

3

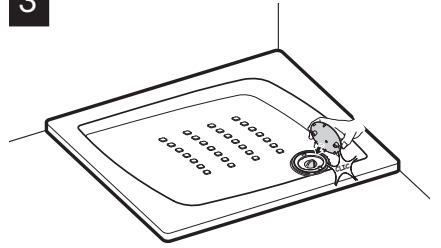

A

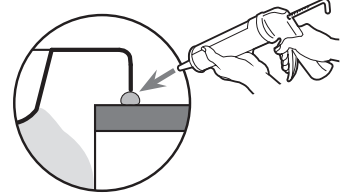
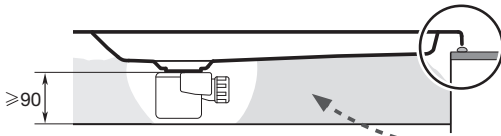

B

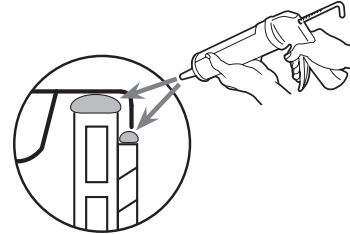
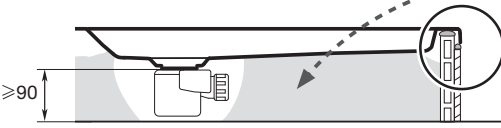

C *

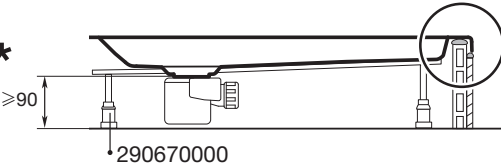

* Daiquiri 900x700, Daiquiri 900x750, Daiquiri 1000x700, Daiquiri 1000x800.

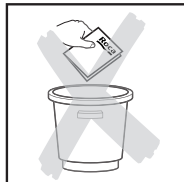
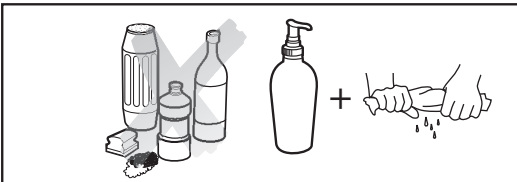
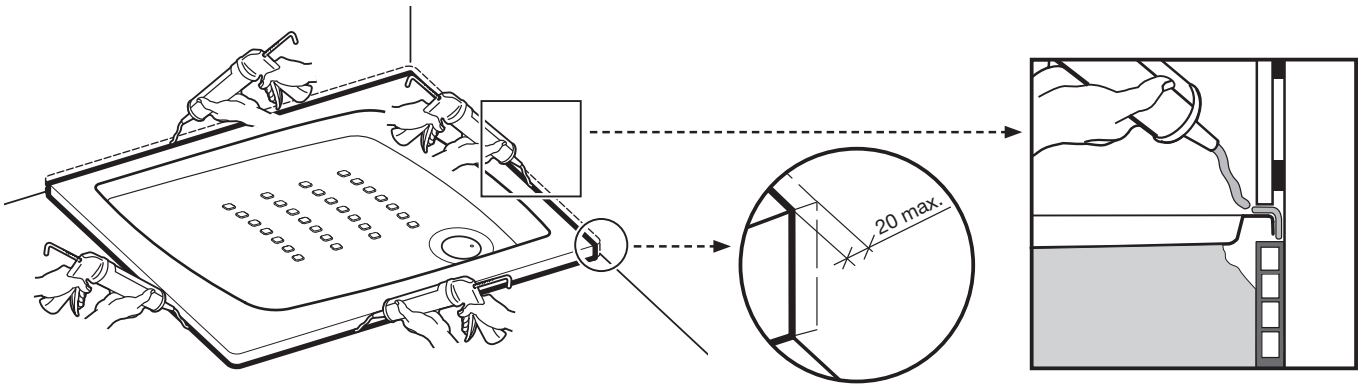

Roca Sanitario, S.A.
Avda. Diagonal, 513
08029 Barcelona
SPAIN
www.roca.es

902
304
848

LÍNEA DE
ATENCIÓN AL
CONSUMIDOR
ESPAÑA

902
400
423

SERVICIO
TÉCNICO
ESPAÑA

Roca

27G015d
080222